

IN74AC151

8-Input Data Selector/Multiplexer
High-Speed Silicon-Gate CMOS

The IN74AC151 is identical in pinout to the LS/ALS151, HC/HCT151. The device inputs are compatible with standard CMOS outputs; with pullup resistors, they are compatible with LS/ALS outputs.

The device selects one of the eight binary Data Inputs, as determined by the Address Inputs. The Strobe pin must be at a low level for the selected data to appear at the outputs. If Strobe is high, the Y output is forced to a low level and the \bar{Y} output is forced to a high level.

- Outputs Directly Interface to CMOS, NMOS, and TTL
- Operating Voltage Range: 2.0 to 6.0 V
- Low Input Current: 1.0 μ A; 0.1 μ A @ 25°C
- High Noise Immunity Characteristic of CMOS Devices
- Outputs Source/Sink 24 mA

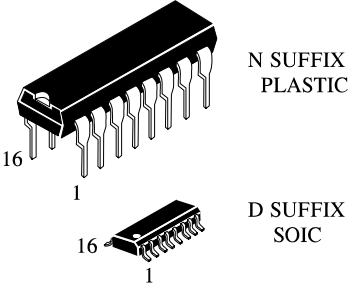

N SUFFIX
PLASTIC

D SUFFIX
SOIC

ORDERING INFORMATION
 IN74AC151N Plastic
 IN74AC151D SOIC
 T_A = -40° to 85° C for all packages

LOGIC DIAGRAM

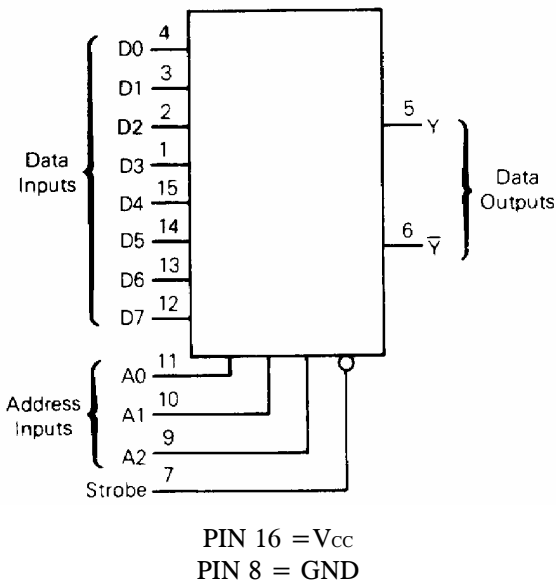

PIN ASSIGNMENT

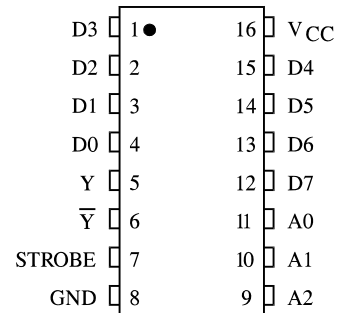

FUNCTION TABLE

Inputs				Outputs	
A2	A1	A0	Strobe	Y	\bar{Y}
X	X	X	H	L	H
L	L	L	L	D0	$\overline{D0}$
L	L	H	L	D1	$\overline{D1}$
L	H	L	L	D2	$\overline{D2}$
L	H	H	L	D3	$\overline{D3}$
H	L	L	L	D4	$\overline{D4}$
H	L	H	L	D5	$\overline{D5}$
H	H	L	L	D6	$\overline{D6}$
H	H	H	L	D7	$\overline{D7}$

D0,D1...D7 = the level of the respective D input
 X = don't care

MAXIMUM RATINGS*

Symbol	Parameter	Value	Unit
V _{CC}	DC Supply Voltage (Referenced to GND)	-0.5 to +7.0	V
V _{IN}	DC Input Voltage (Referenced to GND)	-0.5 to V _{CC} +0.5	V
V _{OUT}	DC Output Voltage (Referenced to GND)	-0.5 to V _{CC} +0.5	V
I _{IN}	DC Input Current, per Pin	±20	mA
I _{OUT}	DC Output Sink/Source Current, per Pin	±50	mA
I _{CC}	DC Supply Current, V _{CC} and GND Pins	±50	mA
P _D	Power Dissipation in Still Air, Plastic DIP+ SOIC Package+	750 500	mW
T _{stg}	Storage Temperature	-65 to +150	°C
T _L	Lead Temperature, 1 mm from Case for 10 Seconds (Plastic DIP or SOIC Package)	260	°C

*Maximum Ratings are those values beyond which damage to the device may occur. Functional operation should be restricted to the Recommended Operating Conditions.

+Derating - Plastic DIP: - 10 mW/°C from 65° to 125°C
SOIC Package: : - 7 mW/°C from 65° to 125°C

RECOMMENDED OPERATING CONDITIONS

Symbol	Parameter	Min	Max	Unit	
V _{CC}	DC Supply Voltage (Referenced to GND)	2.0	6.0	V	
V _{IN} , V _{OUT}	DC Input Voltage, Output Voltage (Referenced to GND)	0	V _{CC}	V	
T _J	Junction Temperature (PDIP)		140	°C	
T _A	Operating Temperature, All Package Types	-40	+85	°C	
I _{OH}	Output Current - High		-24	mA	
I _{OL}	Output Current - Low		24	mA	
t _r , t _f	Input Rise and Fall Time * (except Schmitt Inputs)	V _{CC} = 3.0 V V _{CC} = 4.5 V V _{CC} = 5.5 V	0 0 0	150 40 25	ns/V

*V_{IN} from 30% to 70% V_{CC}

This device contains protection circuitry to guard against damage due to high static voltages or electric fields. However, precautions must be taken to avoid applications of any voltage higher than maximum rated voltages to this high-impedance circuit. For proper operation, V_{IN} and V_{OUT} should be constrained to the range GND ≤ (V_{IN} or V_{OUT}) ≤ V_{CC}.

Unused inputs must always be tied to an appropriate logic voltage level (e.g., either GND or V_{CC}). Unused outputs must be left open.

DC ELECTRICAL CHARACTERISTICS(Voltages Referenced to GND)

Symbol	Parameter	Test Conditions	V _{CC} V	Guaranteed Limits		Unit	
				25 °C	-40°C to 85°C		
V _{IH}	Minimum High-Level Input Voltage	V _{OUT} =0.1 V or V _{CC} -0.1 V	3.0	2.1	2.1	V	
			4.5	3.15	3.15		
			5.5	3.85	3.85		
V _{IL}	Maximum Low - Level Input Voltage	V _{OUT} =0.1 V or V _{CC} -0.1 V	3.0	0.9	0.9	V	
			4.5	1.35	1.35		
			5.5	1.65	1.65		
V _{OH}	Minimum High-Level Output Voltage	I _{OUT} ≤ -50 μA	3.0	2.9	2.9	V	
			4.5	4.4	4.4		
			5.5	5.4	5.4		
		*V _{IN} = V _{IH} or V _{IL}					
		I _{OH} = -12 mA	3.0	2.56	2.46		
I _{OH} = -24 mA	4.5	3.86	3.76				
I _{OH} = -24 mA	5.5	4.86	4.76				
V _{OL}	Maximum Low-Level Output Voltage	I _{OUT} ≤ 50 μA	3.0	0.1	0.1	V	
			4.5	0.1	0.1		
			5.5	0.1	0.1		
		*V _{IN} = V _{IH} or V _{IL}					
		I _{OL} = 12 mA	3.0	0.36	0.44		
I _{OL} = 24 mA	4.5	0.36	0.44				
I _{OL} = 24 mA	5.5	0.36	0.44				
I _{IN}	Maximum Input Leakage Current	V _{IN} = V _{CC} or GND	5.5	±0.1	±1.0	μA	
I _{OLD}	+Minimum Dynamic Output Current	V _{OLD} = 1.65 V Max	5.5		75	mA	
I _{OHD}	+Minimum Dynamic Output Current	V _{OHD} = 3.85 V Min	5.5		-75	mA	
I _{CC}	Maximum Quiescent Supply Current (per Package)	V _{IN} = V _{CC} or GND	5.5	8.0	80	μA	

* All outputs loaded; thresholds on input associated with output under test.

+Maximum test duration 2.0 ms, one output loaded at a time.

Note: I_{IN} and I_{CC} @ 3.0 V are guaranteed to be less than or equal to the respective limit @ 5.5 V V_{CC}

AC ELECTRICAL CHARACTERISTICS($C_L=50\text{pF}$, Input $t_r=t_f=3.0\text{ ns}$)

Symbol	Parameter	V _{CC} * V	Guaranteed Limits				Unit
			25 °C		-40°C to 85°C		
			Min	Max	Min	Max	
t _{PLH}	Propagation Delay, Input A to Output Y or \bar{Y} (Figure 2)	3.3 5.0	3.0 2.5	18.0 13.0	3.0 2.0	20.0 15.0	ns
t _{PHL}	Propagation Delay, Input A to Output Y or \bar{Y} (Figure 2)	3.3 5.0	2.5 2.0	18.0 13.0	2.5 1.5	20.0 15.0	ns
t _{PLH}	Propagation Delay, Strobe to Output Y or \bar{Y} (Figures 4,5)	3.3 5.0	2.5 2.0	13.0 10.0	2.0 1.5	14.0 11.0	ns
t _{PHL}	Propagation Delay, Strobe to Output Y or \bar{Y} (Figures 4,5)	3.3 5.0	1.5 1.5	13.0 10.0	1.5 1.5	14.0 11.0	ns
t _{PLH}	Propagation Delay, Input D to Output Y or \bar{Y} (Figures 1,3)	3.3 5.0	2.5 1.5	14.0 10.5	2.0 1.5	15.5 11.0	ns
t _{PHL}	Propagation Delay, Input D to Output Y or \bar{Y} (Figures 1,3)	3.3 5.0	2.5 1.5	15.0 11.0	2.0 1.5	16.0 12.0	ns
C _{IN}	Maximum Input Capacitance	5.0	4.5		4.5		pF

C _{PD}	Power Dissipation Capacitance	Typical @25°C, V _{CC} =5.0 V		pF
		70		

*Voltage Range 3.3 V is 3.3 V ±0.3 V
Voltage Range 5.0 V is 5.0 V ±0.5 V

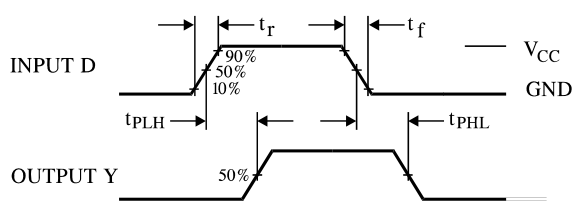

Figure 1. Switching Waveforms

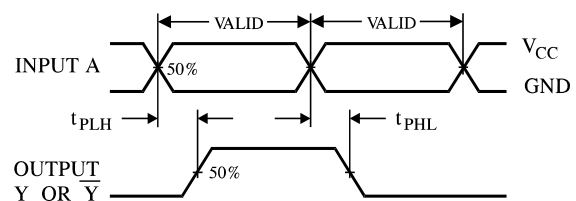

Figure 2. Switching Waveforms

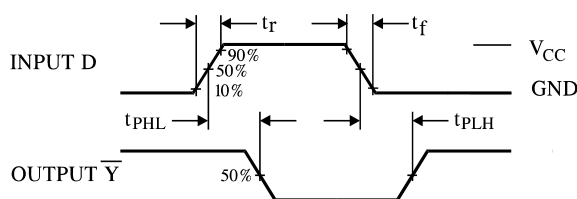

Figure 3. Switching Waveforms

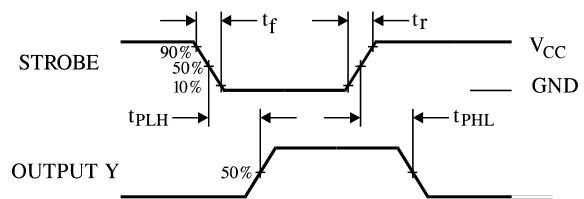

Figure 4. Switching Waveforms

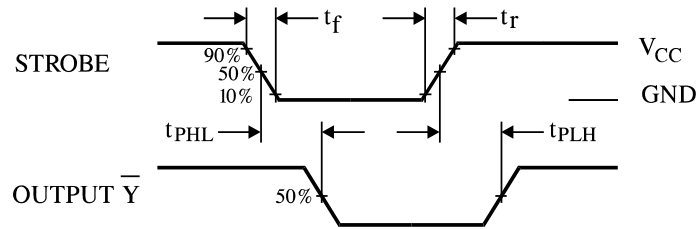

Figure 5. Switching Waveforms

EXPANDED LOGIC DIAGRAM

